

# Installation manual

## Pavilion NEW YORK

Diameter Ø 421/571 cm

Log thickness 44 mm



The producer shall have the right to make technical changes to the product • Technische Änderungen vorbehalten • Le producteur réserve le droit d'effectuer des modifications techniques au produit • Il produttore mantiene il diritto di apportare modifiche tecniche al prodotto • Reservado el derecho a modificaciones técnicas • Valmistaja pidättää oikeuden tehdä tuotteeseen teknisiä muutoksia • Tillverkaren har rätt att utföra tekniska förändringar för produkten

## 1 General information



**Dear client,**

We are glad that you have decided in favour of our garden pavilion!

**Please read the assembly manual carefully before proceeding with the pavilion installation!** You will thus avoid problems and will not waste your time.

### **Recommendations:**

- Keep the pavilion package until its complete assembly in a dry place. Package should be protected from weather conditions (moisture, the sun, etc.) and it shouldn't have direct contact with the ground during stocking period. Do not keep the pavilion package in a heated room!
- When selecting the garden pavilion location, make sure that the pavilion will not be subjected to extreme weather conditions (areas of strong snowfall or winds); otherwise you should attach the pavilion (for instance, with anchors) to the subsoil.



### **Warranty**

Your pavilion is made from high quality spruce and delivered in the natural (unprocessed) form (except foundation joists). If, despite our thorough inspection, you should have complaints, please submit the filled out control sheet and purchase invoice to the product seller.

**ATTENTION: Please be sure to keep the documentation accompanying the pavilion package! The control sheet includes the control number of the pavilion. We can only review complaints if you submit the control number of the pavilion to the seller!**

The warranty does not cover:

- Peculiarities of wood as a natural material
- Wooden details already painted (processed with a wood preservative)
- Wooden details containing whole branches that do not endanger the stability of the pavilion
- Colour tone variations caused by wood structure differences that do not influence wood lifetime
- Wooden details containing (caused by drying) small cracks/gaps that do not pass through and do not influence the structure of the pavilion
- Twisted wooden details if they can nevertheless be installed
- Roof and floor boards that may have on their concealed surfaces some non-planed areas, colour differences and waning
- Complaints resulting from an incompetent manner of the installation of the pavilion or the pavilion subsiding due to an incompetently made foundation
- Complaints caused by introducing self-initiative changes to the pavilion, such as the deformation of wooden details and doors/windows due to an incompetent manner of wood processing; the attachment of storm braces too rigidly, doorframes being screwed onto wall logs, etc.

**The complaints covered by the warranty are satisfied to the extent of replacing the deficient/faulty material. All other demands will be excluded!**



## Garden pavilion painting and maintenance

Wood is a natural material, growing and adapting depending on weather conditions. Large and small cracks, colour tone differences and changes, as well as a changing structure of wood are not errors, but a result of wood growing and a peculiarity of wood as a natural material.

Unprocessed wood (except for foundation joists) becomes greyish after having been left untouched for a while, and can be turn blue and become mouldy. To protect the wooden details of your garden pavilion, you must immediately process them with a wood preservative.

We recommend that you cover the floor boards in advance with a colourless wood impregnation agent, especially the bottom sides of the boards, to which you will no longer have access when the pavilion is assembled. Only this will prevent moisture penetration.

We definitely recommend that you also process the doors and windows with a wood impregnation agent, and do that namely both inside and outside! Otherwise the doors and windows can become twisted.

After the pavilion assembly is completed, we recommend for the conclusive finishing a weather protection paint that will protect wood from moisture and UV radiation.

When painting, use high quality tools and paints, follow the paint application manual and manufacturer's safety and usage instructions. Never paint a surface in strong sunlight or rainy weather. Consult a specialist regarding paints suitable for unprocessed softwood and follow the paint manufacturer's instructions.

Having been properly painted, your garden pavilion's lifetime will increase substantially. We recommend that you inspect the pavilion thoroughly once every six months.

## 2 Preparation for assembly

### Tools and preparation of components

To assemble the garden pavilion, you will need the following tools:



assembly aid



ladder



hammer

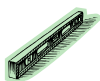

water-level



screwdriver



saw



knife



measuring tape



pliers



drill

**ADVICE:** To avoid splinters, we recommend that you wear the corresponding protective gloves during the assembly process.

## Foundation

A good foundation is the most important aspect guaranteeing the duration and safety of your pavilion. Only a completely level and bearing foundation will ensure problem-free installation of the pavilion, its stability and especially the matching of the doors. With a good foundation, your pavilion will stand for many years more.

Prepare the foundation so that its upper edge extends from the ground to a height of at least 5 cm. At the same time make sure that there are sufficient air apertures under the pavilion floor for ventilation.

We recommend the following foundation options:

- Strip or spot foundation
- Foundation from concrete or pavement slabs
- Cast concrete bed

Prepare the foundation so that foundation joists and every nodal point are propped up on every side with intervals not exceeding 50-60 cm.

Consult an expert in this field or have the foundation prepared by specialists.

## Controlling of parts

Prior to assembly, please check the content of the package. With the help of parts list (included to this installation manual) make sure that all the parts listed in the parts list are included to the package.

### ATTENTION:

- You will find included in the pavilion package one spare log (longest wall log).
- You will find included in the pavilion package one spare board (longest floor board).
- The pavilion package also includes 2-3 marked hitting blocks (wall profile approximately 20-30 cm long).

All of the details listed above **ARE NOT** mentioned in the specification list.

## 3 Garden pavilion assembly

### Preparation of components:

Sort the components based on position number to simplify the finding of the right part while installing the pavilion.

**ATTENTION:** Never place the components directly on grass or a muddy surface because it will be very difficult or even impossible to clean them up later!

### Base frame

The base frame of the pavilion must be completely flat and level to ensure that the installation proceeds without problems. Place the impregnated foundation joists on the prepared foundation in accordance with the drawing (see Technical specifications) and screw them together with 6x120 mm screws. Make sure that the base frame has the same measures as on the drawing. (NB! The base frame can differ +/- 5 mm because of the swelling/ waning of the wood during the transportation. It does not affect the installation of the pavilion.)

**ADVICE:** It is recommended to place between the foundation joists and foundation a damp-proof course that will protect the pavilion from moisture and decay.

**ADVICE:** To ensure protection from wind and storm, it is recommended to attach the foundation joists to the foundation (for this, you can use for instance metal angles, anchors, etc.). The corresponding materials are not included in the supplied kit!

## Walls

When installing the walls, it is important to remember that:

- The logs are always assembled with their tongue upwards!
- If necessary, use the hitting block and hammer! Never directly hit the tongue with the hammer!

Install the walls in accordance with the appended wall plans (see Technical specifications).

The first layer of logs:

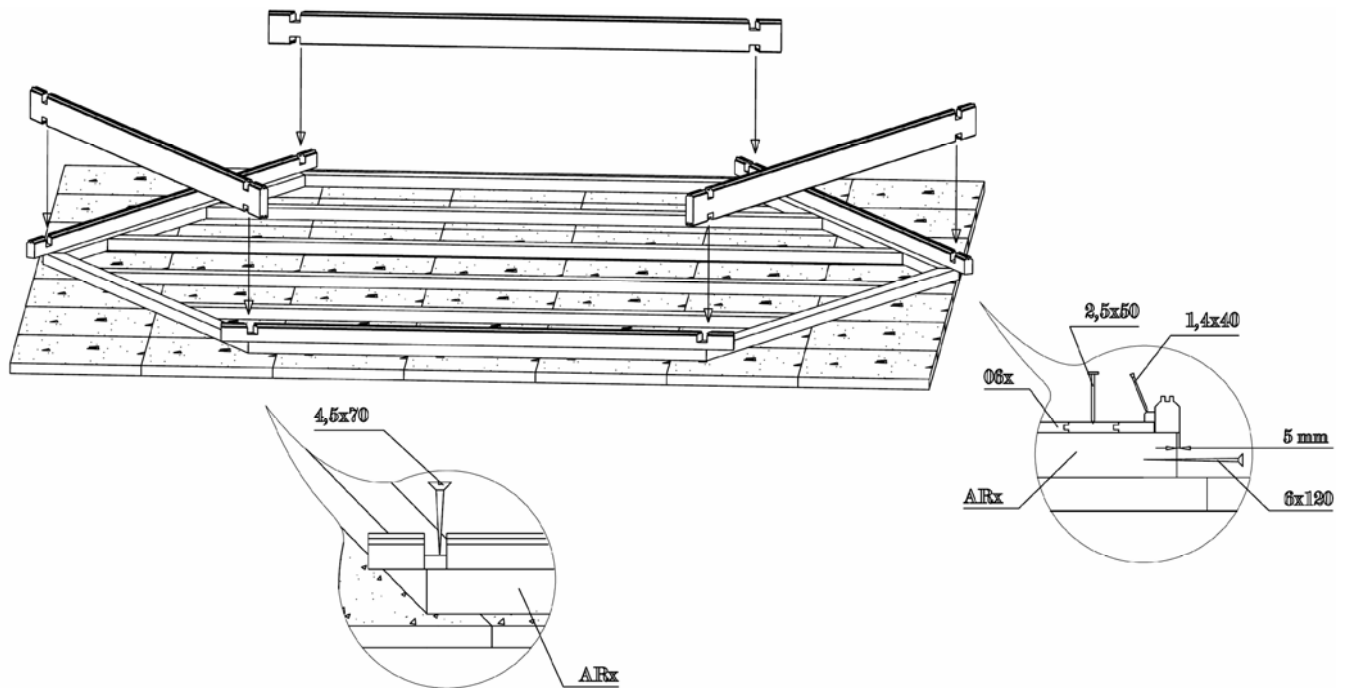

Place the first layer of wall logs on the base frame as shown on the picture that is wall logs and half logs in turns. Make sure that the first layer of logs would reach ca 5 mm over the foundation joists. This way you will protect the garden pavilion against moisture, so the rainwater could easily flow into the ground.

Now remove carefully the wall logs and attach half logs with 4,5x70mm screws to the foundation as shown on the picture. Put the wall logs back to their place.

**ATTENTION:** Make sure that the measurements of the foundation would be the same as given in the Technical specifications.

Continue the installation of the walls according to the wall plans by strongly forcing the wall logs into one another. If necessary, use the hitting block and hammer. At the same time, do not forget to begin the installation of the door and windows.

You should definitely begin the door installation after the 5<sup>th</sup>-6<sup>th</sup> layer of logs.

## Door and window

### Door and window frame:

- By double door and double window, the frames are supplied in separate parts due to transportation requirements and you will have to begin by assembling it.
- To do this, place together the 4 parts of the frame and screw them onto one another with 5x90mm screws.
- Make sure that the part of the frame with the deeper notch is installed upwards. The lateral jamb parts have hinges and are mirrored.
- It is recommended to install the leaves later.

### Assembly of the double window and double door:

#### Window:

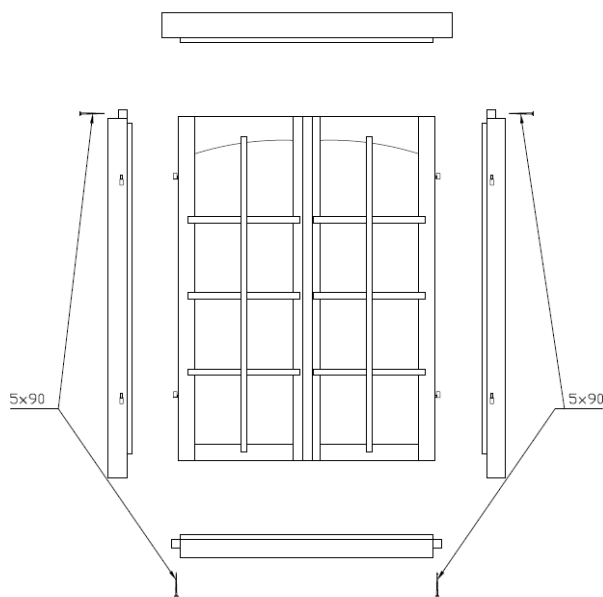

#### Door ver. 1 (PAY44-4242):

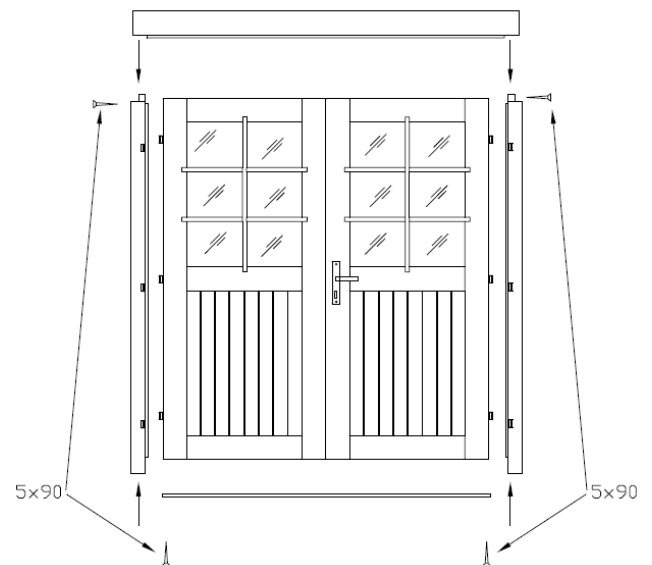

#### Door ver. 2 (PAY44-5742):

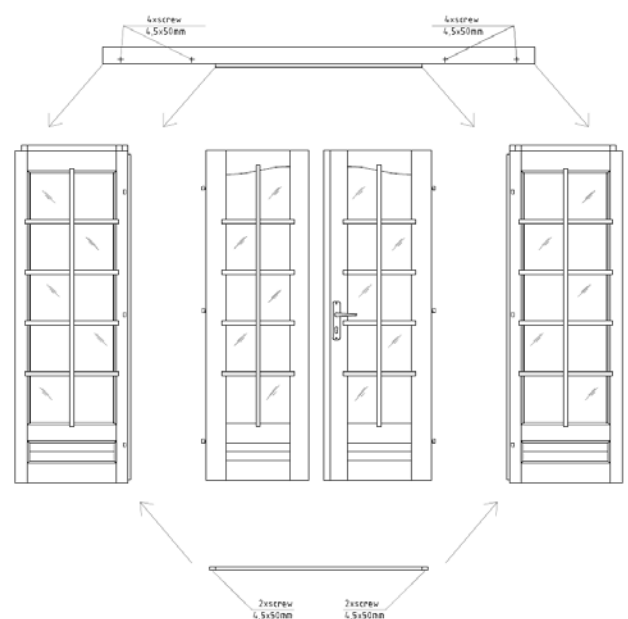

# Installation manual - English

## Door installation:

When the pavilion is installed, place the door leaves on the hinges. To open and close the door, fit the separately packaged lock and handle. If necessary, regulate the door from the hinges. Clean the door glass and fix the door bars with the screws packaged with the bars.

## Window installation:

Install the window similarly to the door. Additionally you need to install the window stops.

**ADVICE:** Definitely make sure that the windows and doors open in the proper direction. The doors open from the inside **to the outside**. The windows of the pavilions also open **to the outside** (the window handles are on the inside).

**ATTENTION:** It is not necessary to fix the doors and windows to the wall logs! If you wish to do this, it will be sufficient to fix them with a couple of screws in the lower part of the frame because as they dry, the wall logs will begin subsiding.

You can conduct the final adjustments of the doors and windows only some 2-3 weeks after the pavilion installation, when the pavilion will have become adapted to weather conditions and its logs settled.

## Roof

Please notice that after assembling wall logs, all walls must be with equal height. After insuring the equal height of the walls, part pos. 151 must be screwed (5x90 mm screw) to walls as shown on the drawing. In case of pavilion PAY44-5742 you must screw part pos. 151 and part pos. 152 (5x90 mm screw) to walls as shown on the drawing.

At first attach both (triangle) halves of the roof (left and right side), using the 5x90 mm screws. This way, 8 triangle roof components are formed for pavilion PAY44-4242. In case of pavilion PAY44-5742 you will get 6 triangle and 4 trapeze roof components.

**ATTENTION:** Attach the roof shingles (not included in house kit) to the roof elements before installing the roof to the garden pavilion.

Have ready some boards with the length ca. 3.60 m for installing pavilion to support the roof elements during installation. The installation of roof elements is possible with 2 persons.

Place one roof element onto the rafter and support the top of the element at the centre of the garden pavilion with the help of the board. In case of pavilion PAY44-5742 start with the middle triangle roof component.

Attach the roof element to the rafter with 5x90 screws as it is shown on the illustration beside.

The next element is assembled exactly the same way. When installing the second element, see that the edge and the top of the roof would remain on the same height as those of the first element.

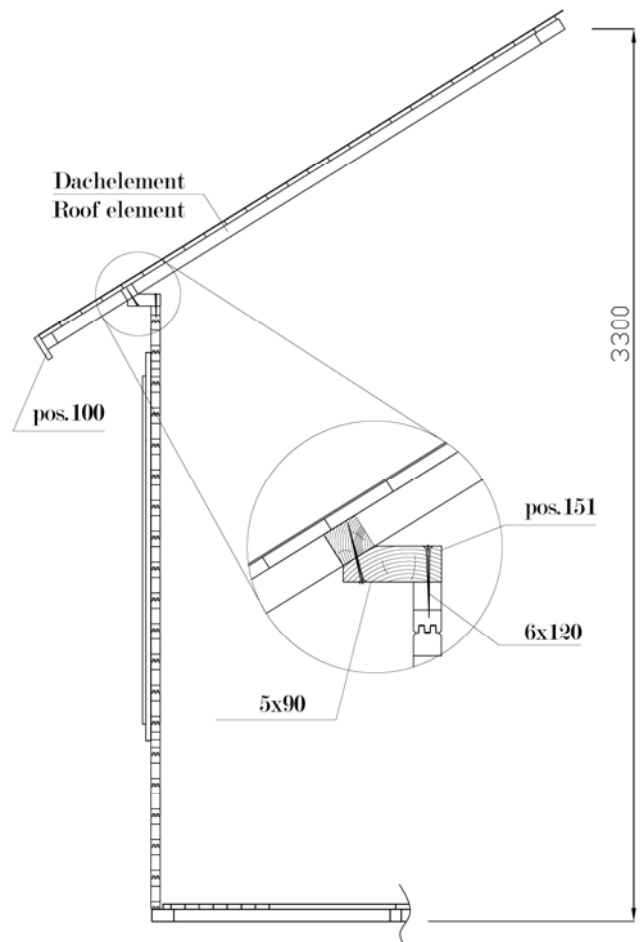

## Installation manual - English

---

When the second element has been attached to the rafter, screw both elements together with 5x90 mm screws. It is recommended to drill the holes first so that the connection of the elements would be stronger.

The rest of the roof elements are assembled the same way.

Usually the installation of the last roof component is the most complicated. If there will remain a gap between the elements unscrew the elements from the walls and push them upwards. On the right place fix the elements again with at least 4 screws of 5x90 mm.

On the contrary, if there will remain too little space for the last element, all the elements should be pushed downwards.

In pavilion PAY44-5742 install the part pos. 160. Fix it with 6x120 mm screws (10 pieces).

Finally, the metal roof cap needs to be installed (NB! Not included in some house kits!).

### Assembly of eave edgings

Attach the eave edgings pos. 100 (in pavilion PAY44-5742 pos. 100 and pos. 101) to the roof elements with screws. Use 4.5x50 mm screws. Ideally the top side of the eave edging should be on the same line with the top side of the roof board.

## Floor

Start assembling the floor from centre with longest, 90° floor boards (pos. 061). Leave gaps of 0,5-0,7 mm between the boards. That is needed to allow floor boards to expand according to weather conditions.

Place the floor boards in the centre of the floor so that groove meets groove. Groove needs to be filled with fitting slats (pos. 150).

After middle section of floor being assembled, move on to the sides of the floor with 45° floor boards. Don't forget to leave small gaps of 0,5-0,7 mm between boards. The last and shortest floor board must be cut to the right size.

Floor boards should be fixed to every foundation bearer with 2,5x50 mm nails.

### Assembly of floor beadings

The floor beadings need to be cut to the right size. Fix the floor beadings with 1,4x40 mm nails.

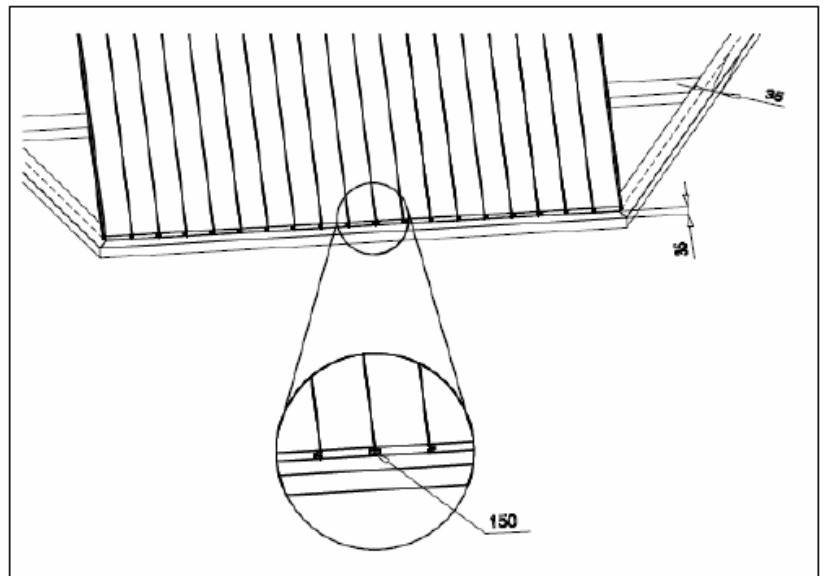



### Storm braces

The storm braces (pos. 140) must be attached in the corners of the pavilions on the both sides of the wall. Fix the storm braces with 6x110 bolts, shims and nuts.

The top of the storm brace (with the round hole) has to be on the same level with the top log of the wall. It is important to drill the  $\varnothing 6$  mm holes through in advance. Place the storm braces on the both sides of the wall.

Drill holes through also from the middle of the oval gaps of the storm braces. Fix the slats with bolts.

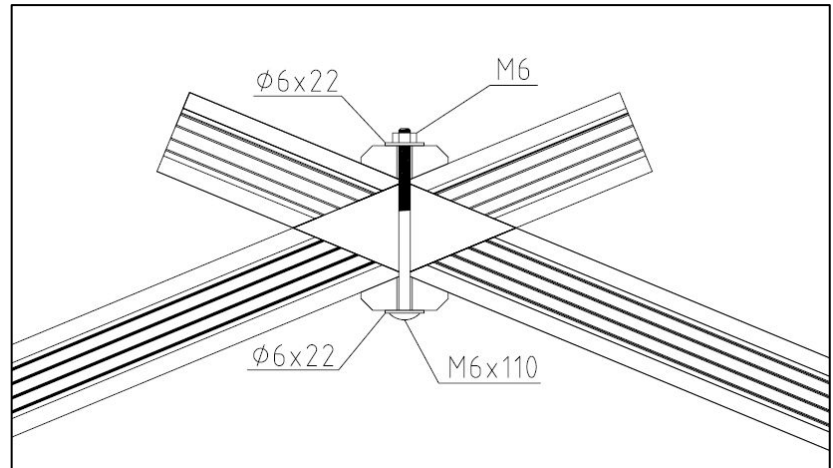

**ADVICE:** Do not turn the bolts tightly so wood can further swell or diminish.

With the pavilion having settled, you should adjust the attachments so the wall logs can settle.

### General advice:

**Problem:** *Gaps appear between the wall logs*

Cause: Additional details are attached to the pavilion that do not allow wood to swell/diminish.

Solutions: If the door/window is attached to the wall logs with screws/nails, remove these screws/nails;  
If the storm brace is screwed on too tightly, loosen its attachment;  
If (rain water) pipes are installed on the wall, loosen their attachments;

**Problem:** *The doors and windows become stuck.*

Cause: The pavilion/foundation has settled.























Solution: Check whether the pavilion is level. Level the foundation joists and walls.

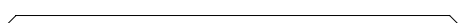
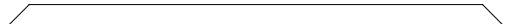
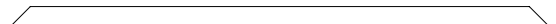

Cause: The doors and windows have swelled due to moisture.



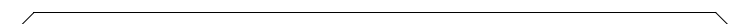



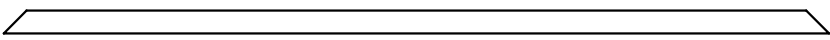
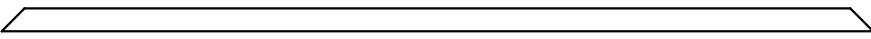
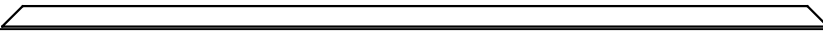
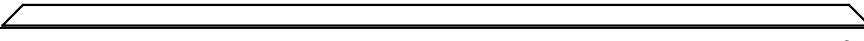
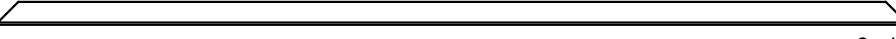
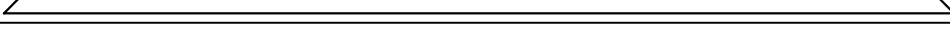
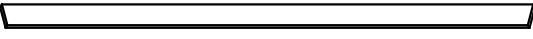
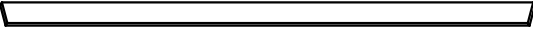
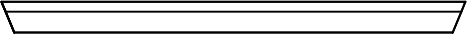
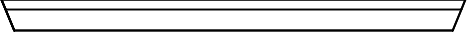

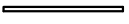
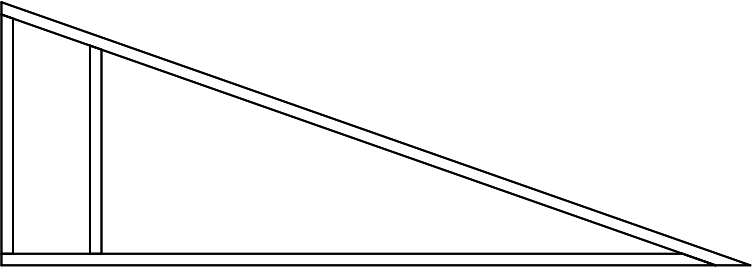
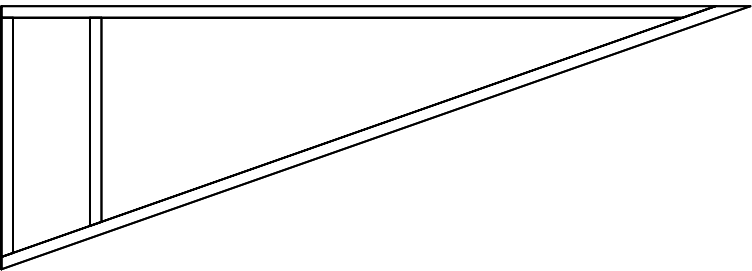
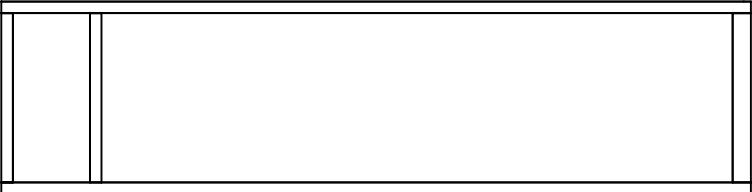

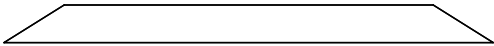
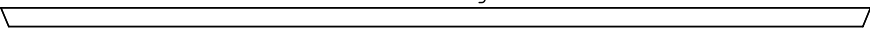
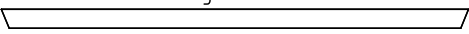
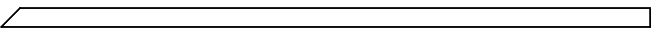
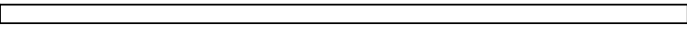
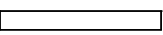







Solution: Adjust the door and window hinges; if necessary, plane the door or window narrower.

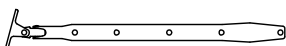

**We wish you total success with the pavilion installation and much joy with this pavilion for many years to come!**

| Pos  | SPECIFICATION-STÜCKLISTE-NOMENCLATURE-ELEMENTI-ESPECIFICACIÓN<br>"Y44-5742"                  | Pcs                                                                                   | Profile<br>(mm) | Length<br>(mm) |
|------|----------------------------------------------------------------------------------------------|---------------------------------------------------------------------------------------|-----------------|----------------|
| 001a |             | 1                                                                                     | 44x55           | 542            |
| 001b |             | 1                                                                                     | 44x55           | 542            |
| 001  |            | 1                                                                                     | 44x55           | 3485           |
| 002  |             | 17                                                                                    | 44x114          | 542            |
| 003  |             | 17                                                                                    | 44x114          | 542            |
| 004  |            | 19                                                                                    | 44x114          | 3485           |
| 005  |  Ohne Nut  | 2                                                                                     | 44x114          | 3485           |
| 006  |             | 62                                                                                    | 44x114          | 1985           |
| 007  |             | 2                                                                                     | 44x114          | 1985           |
| 008  |             | 46                                                                                    | 44x114          | 487            |
| 009  |             | 46                                                                                    | 44x114          | 487            |
| 010  |           | 2                                                                                     | 44x114          | 1985           |
| 011  |           | 4                                                                                     | 44x55           | 1985           |
| 012  |           | 2                                                                                     | 44x55           | 1985           |
| 013  |  Ohne Nut | 2                                                                                     | 44x114          | 1985           |
| 060  | Floor board- Fussbodenbrett- Madrier du plancher -<br>Tavola pavimento- Tabla de suelo       |  |                 |                |
| 061  |  2x90°   | 36                                                                                    | 19x89           | 4115           |
| 062  |  2x45°    | 2                                                                                     | 19x89           | 1780           |
| 063  |  2x45°    | 2                                                                                     | 19x89           | 1959           |
| 064  |  2x45°    | 2                                                                                     | 19x89           | 2139           |
| 065  |  2x45°    | 2                                                                                     | 19x89           | 2318           |
| 066  |  2x45°    | 2                                                                                     | 19x89           | 2498           |
| 067  |  2x45°    | 2                                                                                     | 19x89           | 2677           |
| 068  |  2x45°   | 2                                                                                     | 19x89           | 2857           |
| 069  |  2x45°   | 2                                                                                     | 19x89           | 3036           |

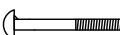
| Pos  | SPECIFICATION-STÜCKLISTE-NOMENCLATURE-ELEMENTI-ESPECIFICACIÓN<br>"Y44-5742"                                                                                                     | Pcs | Profile<br>(mm) | Length<br>(mm) |
|------|---------------------------------------------------------------------------------------------------------------------------------------------------------------------------------|-----|-----------------|----------------|
| 0610 |  2x45°                                                                                        | 2   | 19x89           | 3216           |
| 0611 |  2x45°                                                                                        | 2   | 19x89           | 3395           |
| 0612 |  2x45°                                                                                        | 2   | 19x89           | 3575           |
| 0613 |  2x45°                                                                                        | 2   | 19x89           | 3754           |
| 0614 |  2x45°                                                                                        | 2   | 19x89           | 3934           |
| 0615 |  2x45°                                                                                        | 2   | 19x89           | 4113           |
| 150  | Fitting slat- Montagebrett- Tableau de montage- Tavola di montaggio- Tabla de montaje                                                                                           | 5   | 6x12            | 1200           |
| 100  |                                                                                               | 6   | 19x95           | 2086           |
| 101  |                                                                                               | 2   | 19x95           | 3586           |
| 151  |                                                                                               | 6   | 44x120          | 1808           |
| 152  |                                                                                               | 2   | 44x120          | 3308           |
| 131  | Floor beading- Fussbodenleiste- Baguette du plancher- Listello pavimento- Listón de suelo    | 10  | 19x19           | 1800           |
| 140  | Storm brace- Sturmleiste- Protection contre le vent- Antivento- Protector contra tormentas  | 16  | 19x45           | 2170           |
| 156  | Slat- Leiste- Baguette- Listello- Listón                                                    | 1   | 19x45           | 2400           |
| 170  | Roof element- Dachelement- Panneau de toit- Elemento di tetto- Elemento de tejado           | 8   | 61x1030         | 2918           |
| 171  | Roof element- Dachelement- Panneau de toit- Elemento di tetto- Elemento de tejado           | 8   | 61x1030         | 2918           |
| 170  | Roof element - Dachhälfte                                                                   | 4   | 61x750          | 2920           |

| Pos | SPECIFICATION-STÜCKLISTE-NOMENCLATURE-ELEMENTI-ESPECIFICACIÓN<br>"Y44-5742"                                                                                                           | Pcs | Profile<br>(mm) | Length<br>(mm) |
|-----|---------------------------------------------------------------------------------------------------------------------------------------------------------------------------------------|-----|-----------------|----------------|
| 160 | Purlin- Dachpfette- Arbalétrier<br>Arcareccio- Vigueta de tejado                                    | 1   | 44x140          | 1823           |
| AR1 | Foundation- Fundament- Fondation- Fondazione- Vigas de cimentación 2x68°<br>                        | 2   | 60x80           | 3241           |
| AR2 | Foundation- Fundament- Fondation- Fondazione- Vigas de cimentación 2x68°<br>                         | 6   | 60x80           | 1741           |
| AR3 | Foundation- Fundament- Fondation- Fondazione- Vigas de cimentación 90°/45°<br>                       | 4   | 60x80           | 2221           |
| AR4 | Foundation- Fundament- Fondation- Fondazione- Vigas de cimentación 2x90°<br>                         | 8   | 60x80           | 2791           |
| AR5 | Foundation- Fundament- Fondation- Fondazione- Vigas de cimentación 2x90°<br>                         | 6   | 60x80           | 600            |
|     | Fixing kit- Befestigungsset- Moyens de fixation-<br>Materiale di fissaggio- Kit de fijación         | 1   |                 |                |
|     | Cylinder- Zylinderschloss- Serrure a mortaiser-<br>Serratura a cilindro- Bombin 30.40              | 1   |                 |                |
|     | Door fittings- Türbeschlag- Ferrure- Ferramenta porta-<br>Manilla puerta- QULLinkjakate             | 1   |                 |                |
|     | Window fittings- Fenstergriff- Poigne de la<br>fenêtre- Maniglia finestra- Manilla (ventana)       | 8   |                 |                |
|     | Screw- Schraube- Vis- Vite- Tornillo- 2.5x16mm                                                     | 2   |                 |                |
|     | Screw- Schraube- Vis- Vite- Tornillo - 3x20mm                                                    | 96  |                 |                |
|     | Keeper- Schliessblech- Tole- Lamiera- Aldaba de candado                                          | 1   |                 |                |
|     |                                                                                                                                                                                       |     |                 |                |
|     | Screw- Schraube- Vis- Vite- Tornillo- 4.5x50mm                                                    | 34  |                 |                |
|     | Screw- Schraube- Vis- Vite- Tornillo- 4.5x70mm                                                    | 12  |                 |                |
|     | Screw- Schraube- Vis- Vite- Tornillo- 5x90mm                                                      | 198 |                 |                |
|     | Screw- Schraube- Vis- Vite- Tornillo- 6x120mm                                                     | 54  |                 |                |
|     | Nail- Nagel- Clou- Chiodo- Clavo- 1.4x40mm                                                       | 30  |                 |                |
|     | Nail- Nagel- Clou- Chiodo- Clavo- 2.5x50mm                                                        | 500 |                 |                |
|     | Window stop- Fensterfeststelle- Crémaillere- Fissativo finestra-<br>Fijador de ventana- QAF240Zn  | 8   |                 |                |
|     | Nut- Schraubenmutter- Écrou- Dado- Tuerca<br>- M6mm                                               | 24  |                 |                |
|     | Bolt -Schloss-schraube -Boulon- Bullone- Perno<br>- M6x110mm                                      | 24  |                 |                |
|     | Washer- Dichtscheibe- Joint- Rondella- Arandela<br>- 6x22mm                                       | 48  |                 |                |
| 190 | Seal- Gummidichtung- Joint d'isolation- Guarnizione-<br>Burlete                                   | 1   |                 | 27000          |



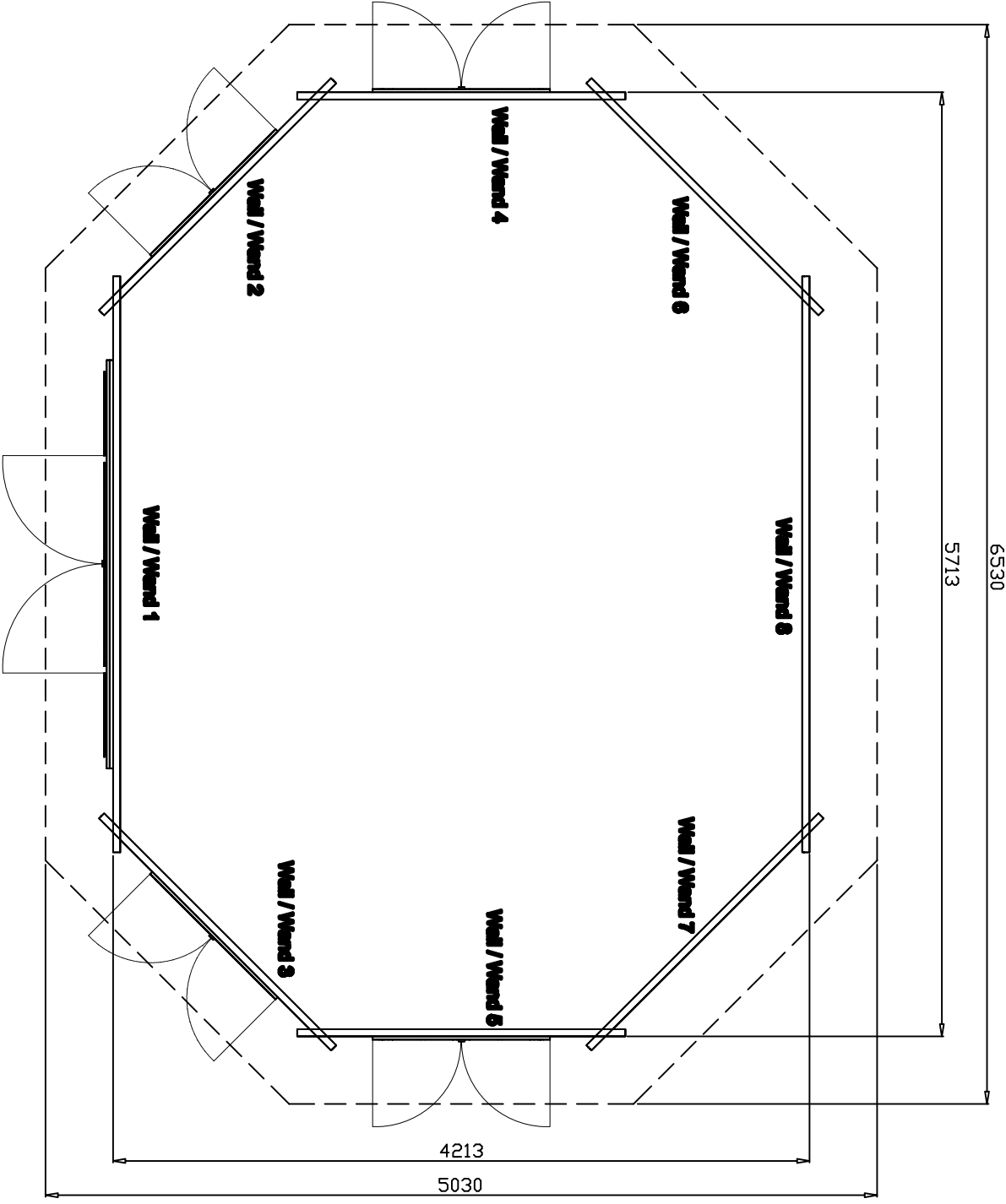

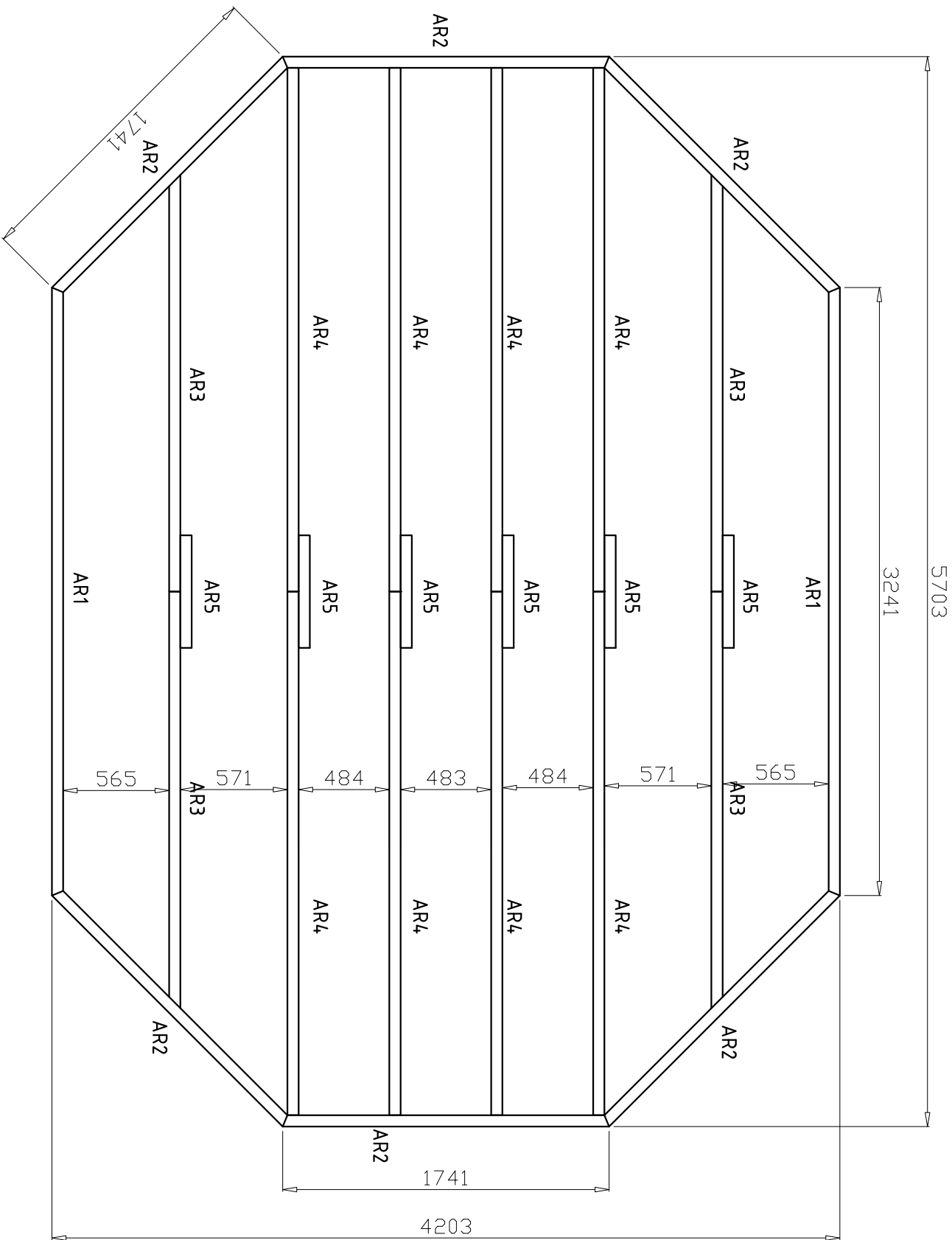





1985

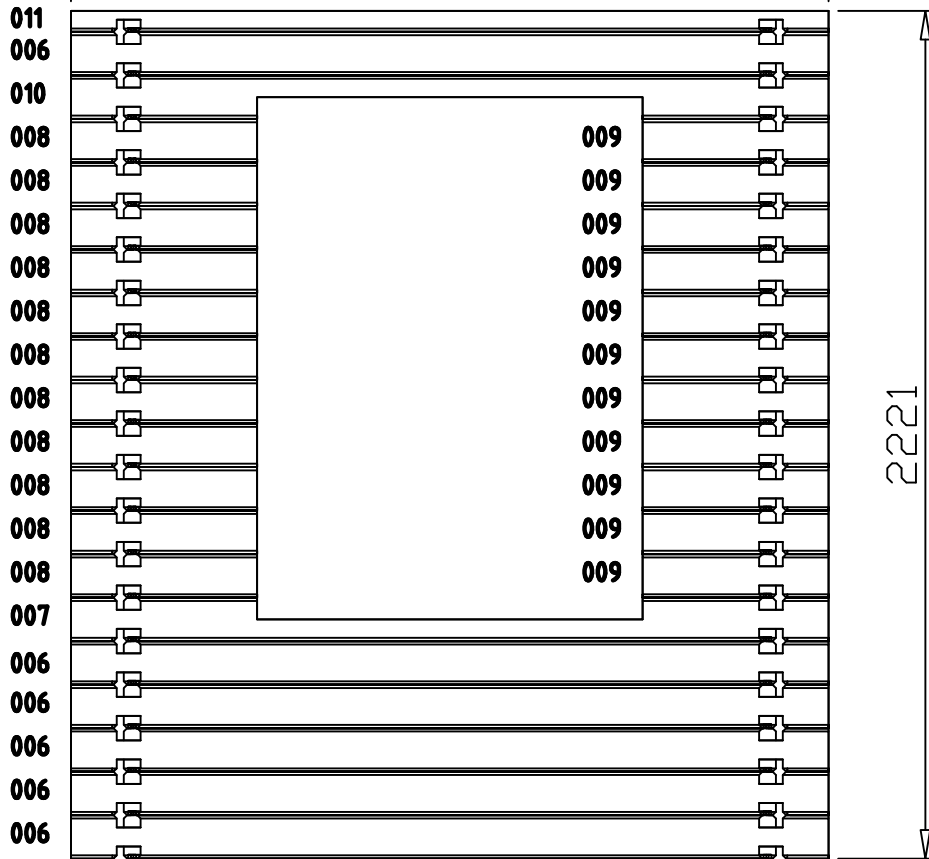

**Wall / Wand 2 & 3**

1985

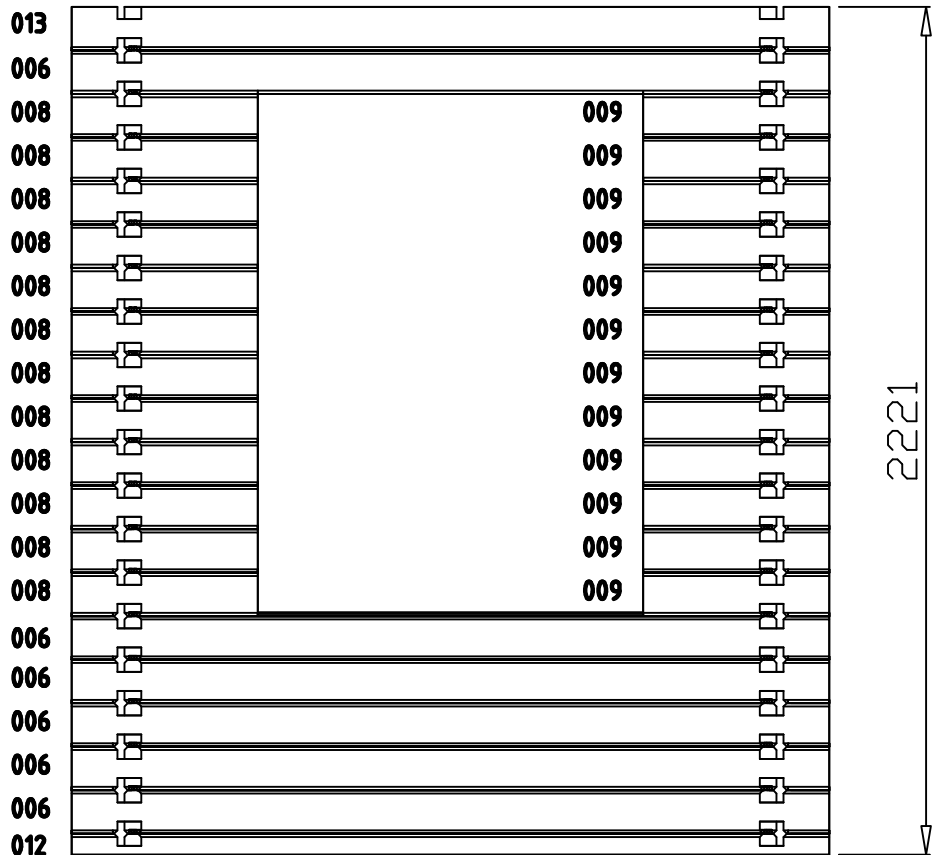

Wall / Wand 4 & 5

1985

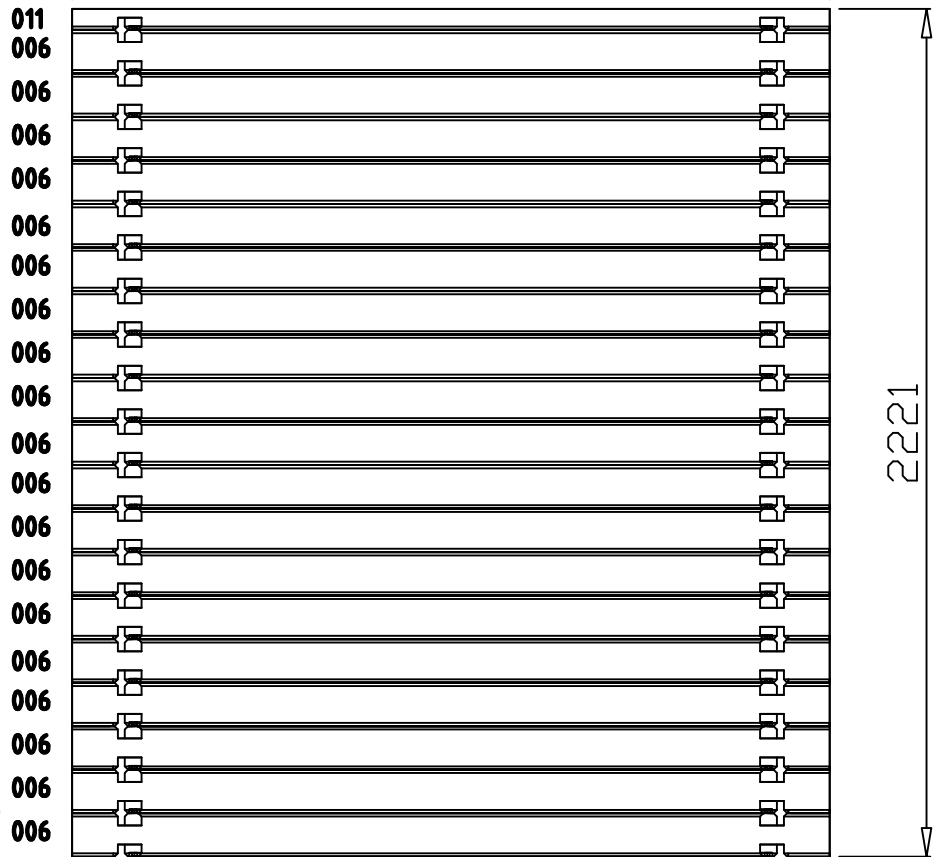

**Wall / Wand 6 & 7**

**Wall / Wand 8**

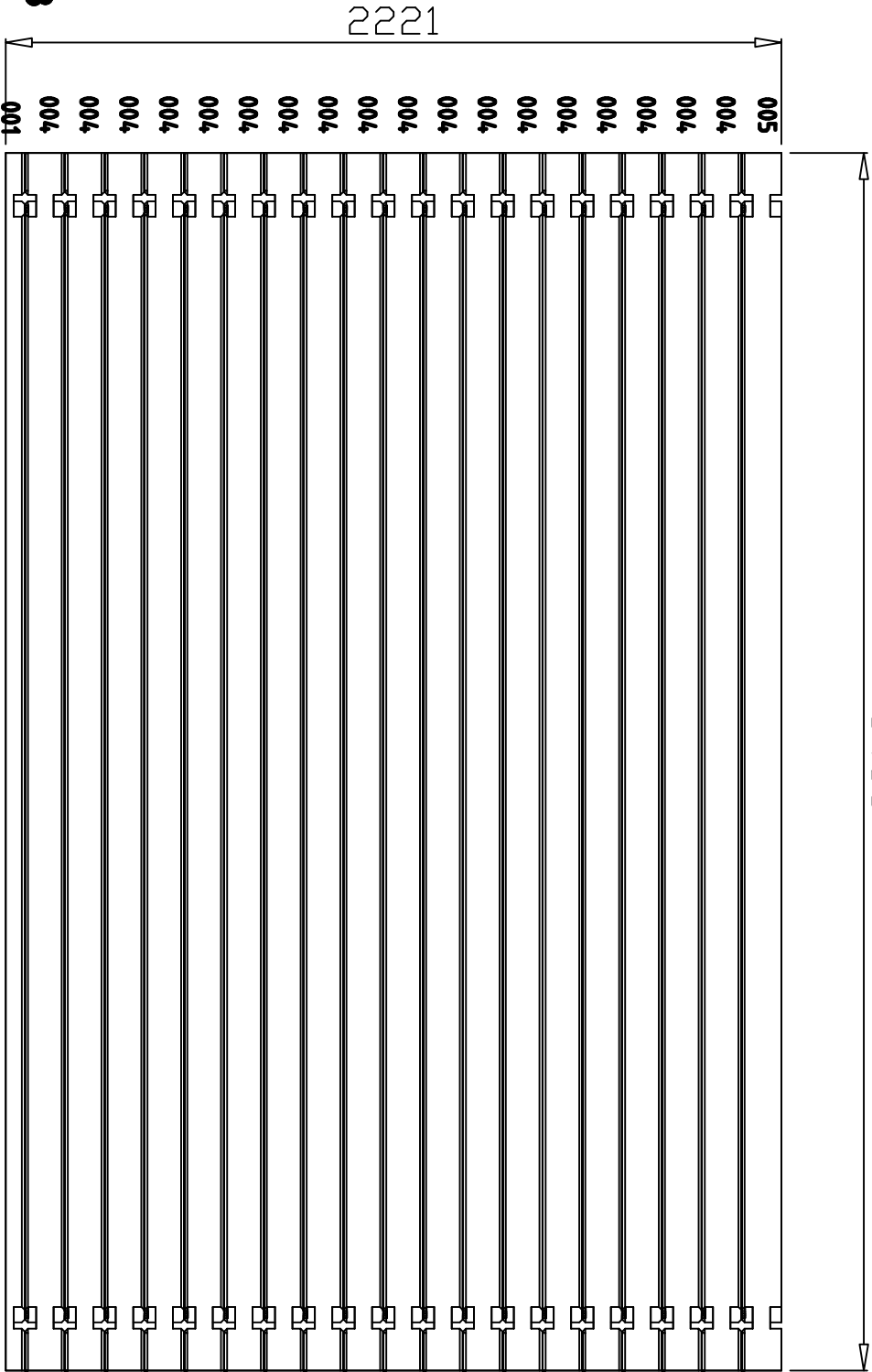

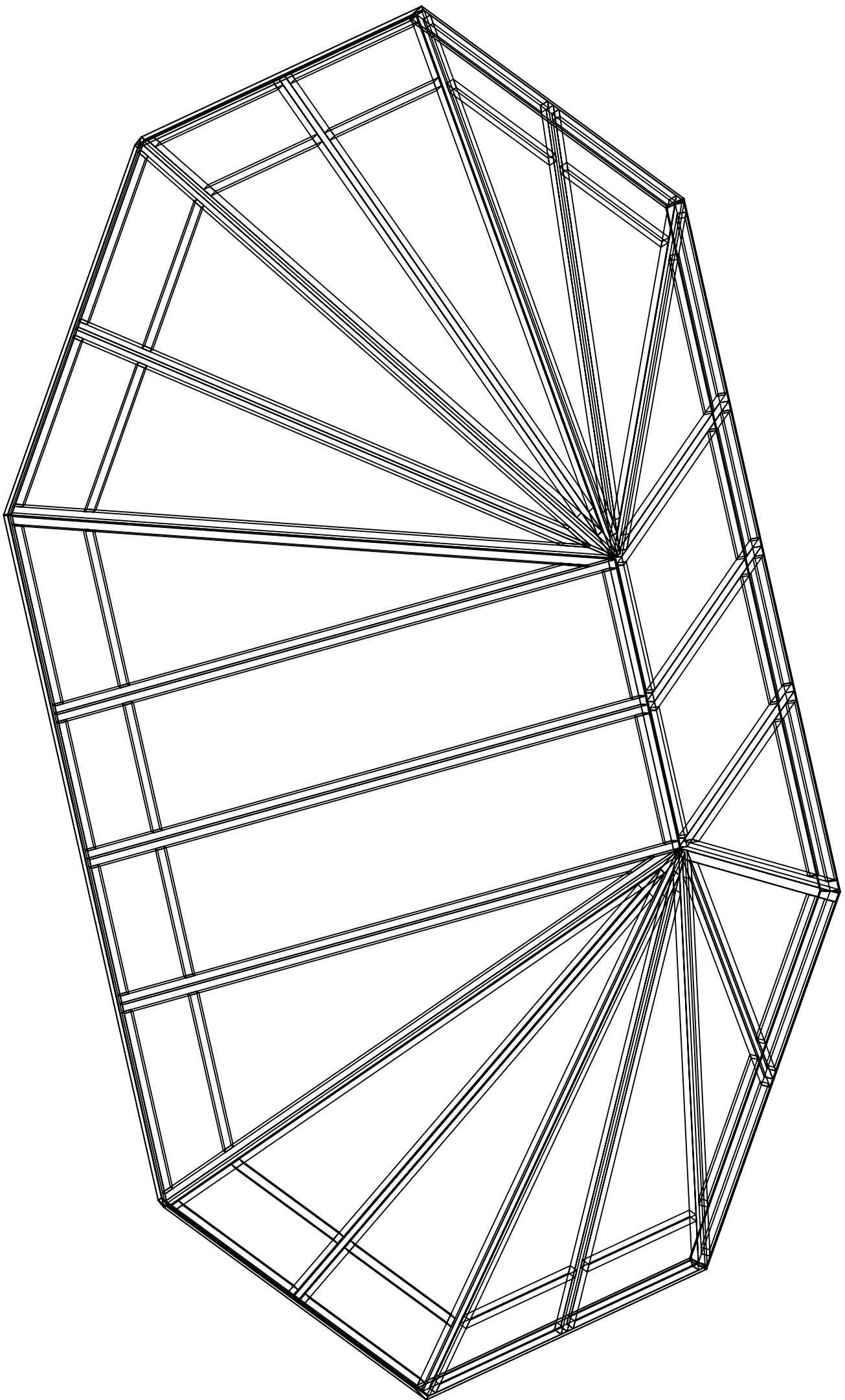

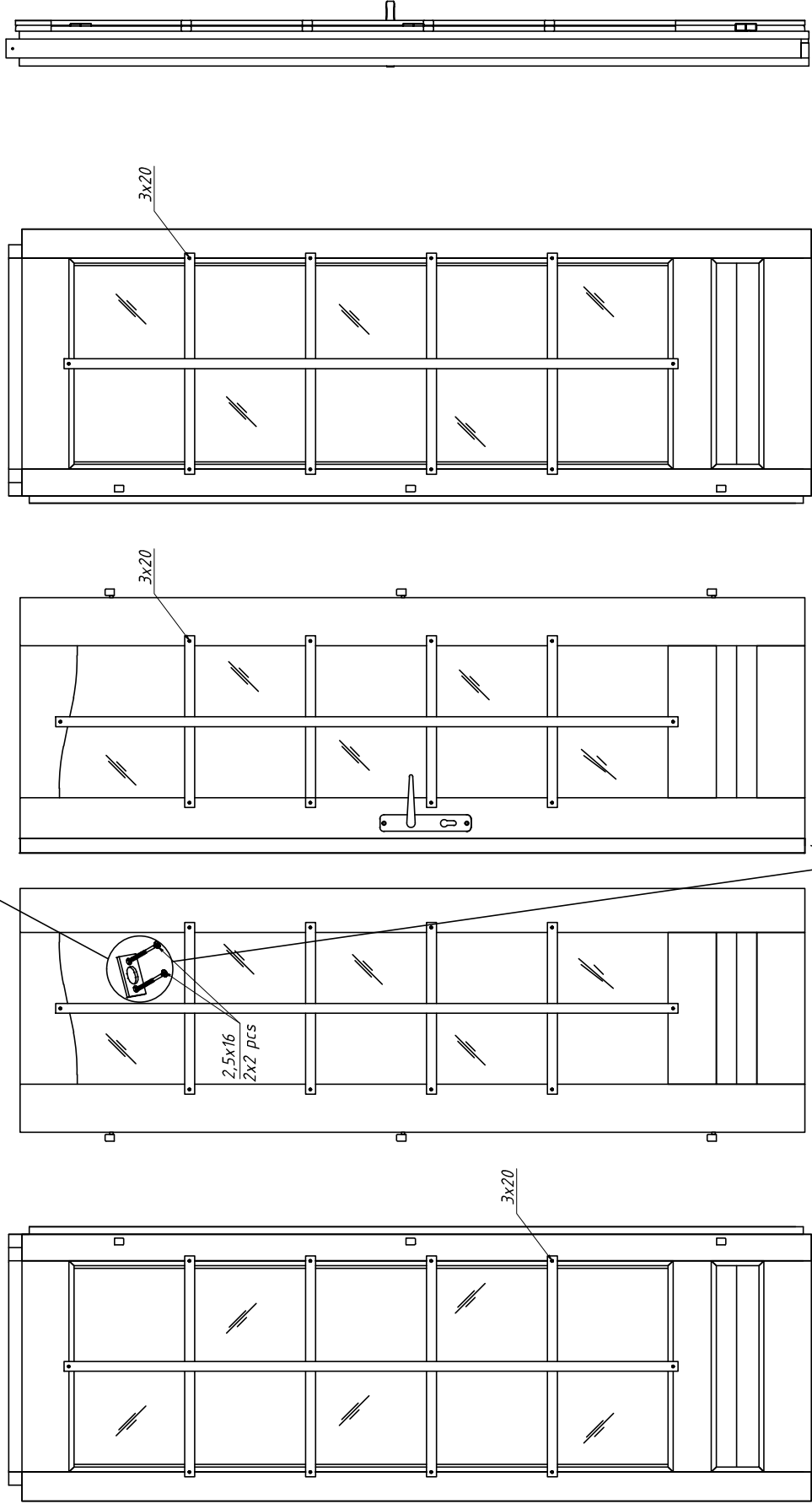
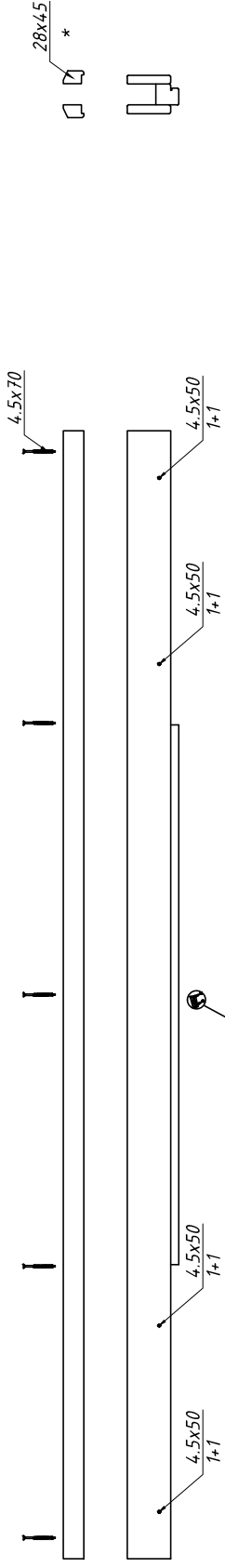
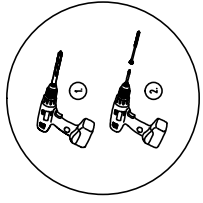

\* Les spécifications peuvent varier selon le modèle spécifique  
 \* Dependiendo del modelo, la especificación puede cambiar  
 \* Le specifiche possono variare a seconda del modello

\* Die Spezifikation können je nach Modell unterschiedlich sein

\* The specification may vary depending on the specific model

4.5x50

4.5x50