

# Installation manual

## NORDIC HOUSE HELSINKI

Width 557 x Depth 576 cm

Log thickness 18 mm



The producer shall have the right to make technical changes to the product • Technische Änderungen vorbehalten • Le producteur réserve le droit d'effectuer des modifications techniques au produit • Il produttore mantiene il diritto di apportare modifiche tecniche al prodotto • Reservado el derecho a modificaciones técnicas • Produsent forbeholder seg retten til å endre tekniske egenskaper ved produktet • Alle rechten en technische wijzigingen voorbehouden • Valmistaja pidättää oikeuden tehdä tuotteeseen teknisiä muutoksia • Tillverkaren har rätt att utföra tekniska förändringar för produkten

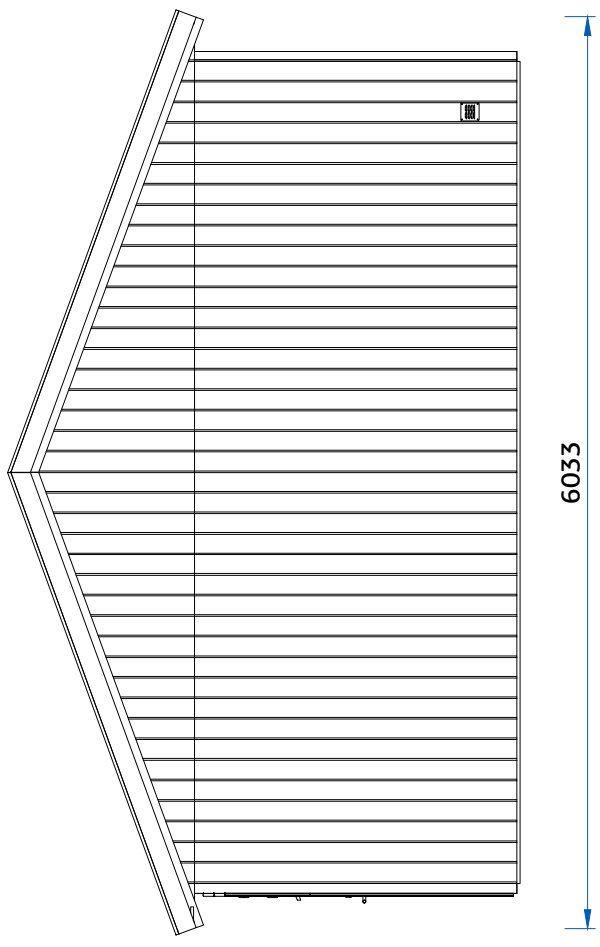
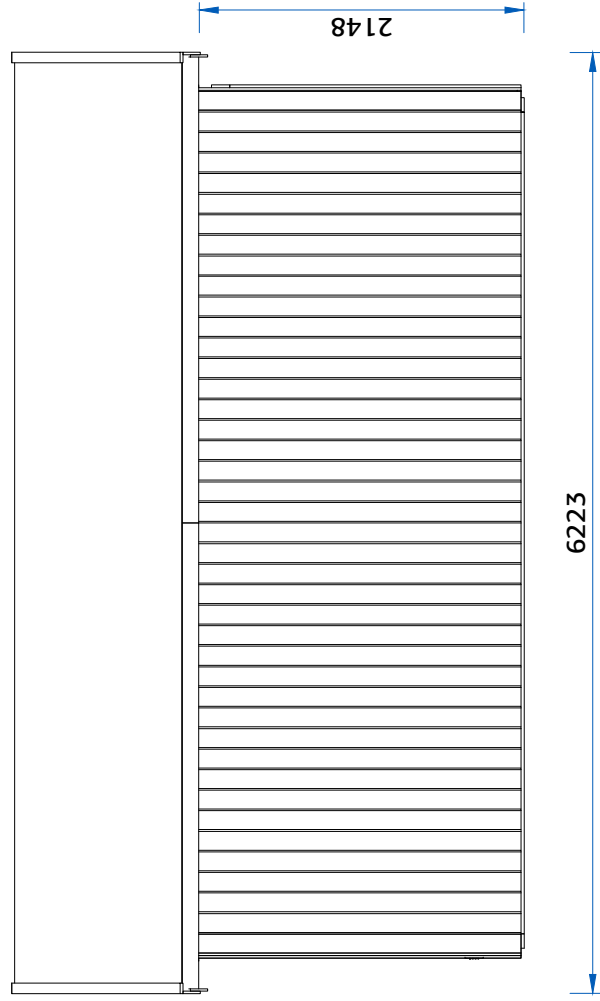
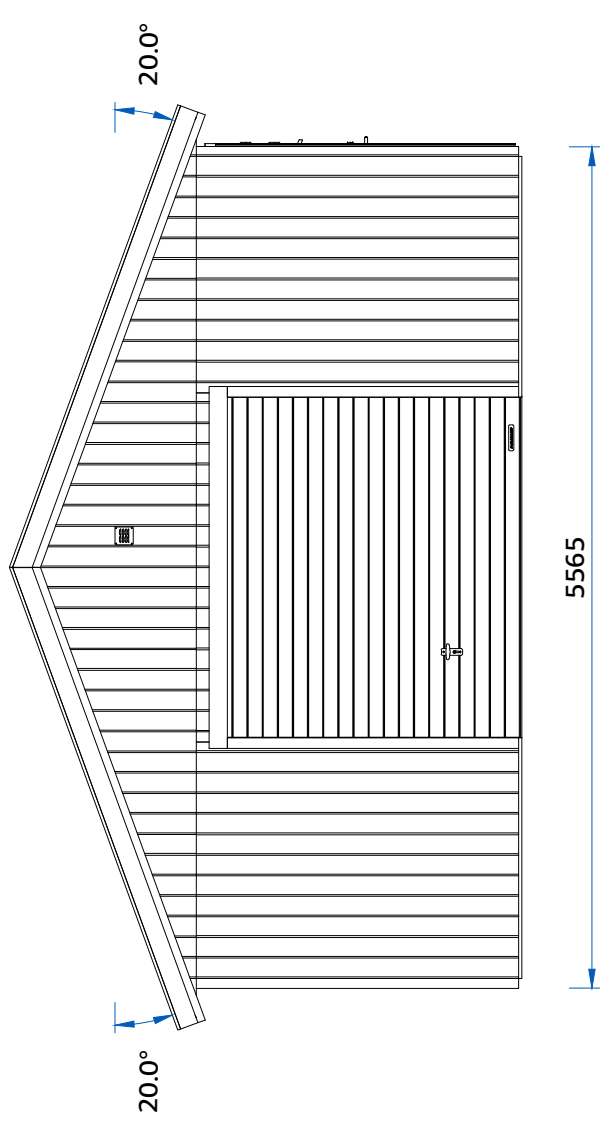
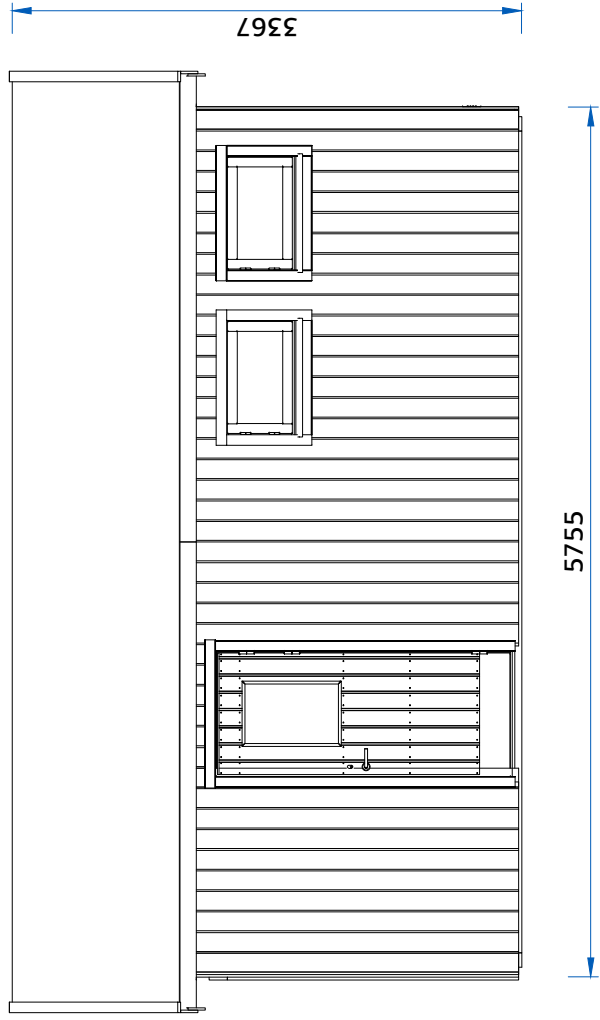

Object name

ANDRE 28.5M2

**Palmako**  
LEHETUS GRUPP  
AS Palmako  
Näituse 25, Tartu 50009, Estonia  
tel. +372 73 55 550  
fax. +372 73 55 544  
www.palmako.com

Drawing

Elevations

Customer	Log
Drawn by	007
Date	30.11.2017
File	Andre_28.5m2.dwg

Scale

1:50



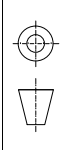

Paper





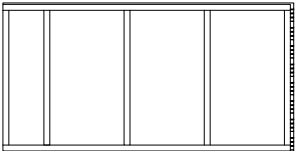
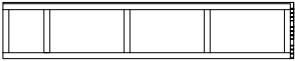
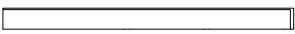

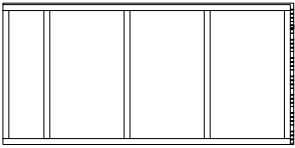
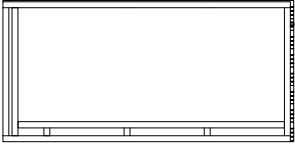
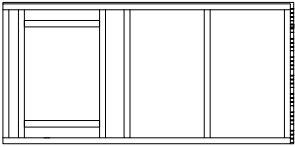

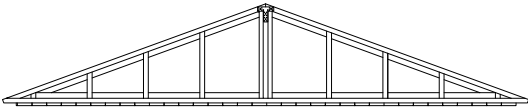
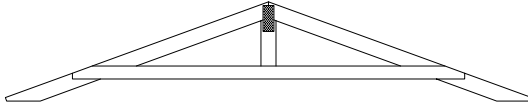
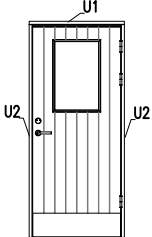
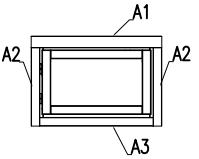

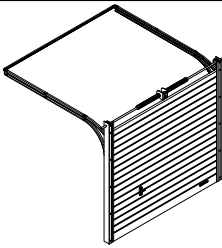













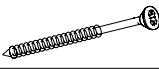

A3

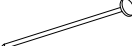
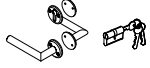

Page

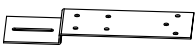
1

EL1		2155 x 1097 x 160	12
EL2		2155 x 554 x 160	2
EL3		2155 x 169 x 65	2
EL4		2155 x 160 x 74	2
EL5		2155 x 1019 x 160	1
EL6		2155 x 1027 x 160	1
EL7		2155 x 1097 x 160	1
EL8		2155 x 1097 x 160	2
EL9		2310 x 202 x 160	1
EL10		5990 x 1191 x 160	2
EL11		5990 x 1166 x 101	9
U105-21-920R	 <p>U1 - 19x45x980 2 pcs U2 - 19x70x1980 4 pcs</p>	870 x 1985 x 105	1
A105-8R	 <p>A1 - 19x70x830 2 pcs A2 - 19x70x1050 4 pcs A3 - 19x70x630 2 pcs</p>	785 x 475 x 105	2

TU00-31Y			2210 x 1885	1
1		Impregnated	45 x 95 x 5435	3
2		Impregnated	45 x 95 x 1590	2
3			44 x 95 x 5471	2
4			19 x 89 x 3695	72
5			19 x 89 x 2495	72
6			32 x 40 x 3180	4
7			16 x 120 x 3260	8
8			19 x 70 x 3260	4
9			19 x 95 x 3095	4
10			28 x 160 x 1928	2
11			28 x 160 x 2254	1
12			19 x 120 x 2394	1
13			19 x 70 x 1925	2
14			19 x 70 x 2200	4
F1			70 x 70 x 55	18
F2			Ø 6 x 120	8
F3			Ø 5 x 90	240
F4			Ø 4.5 x 50	320
F5			Ø 4 x 40	220
F6			Ø 2,2 x 50	870
F7			QULlink/ASSA QULSydamik/ASSA QULSydamikkate/ASSA	1 set
F8		QKR4_5x25YZn	Ø 4.5 x 25	8
F9		QTU	130x147toruga	2
F10		KOMM-MTU00-31Ylukk		1
F11		QVedrutrald	23x100x360	1
F12		QKSP08x20Zn	Ø 8 x 20	4
F13		QMU8	M8	4
F14		QKSKR8x50Zn	Ø 8 x 50	4

1

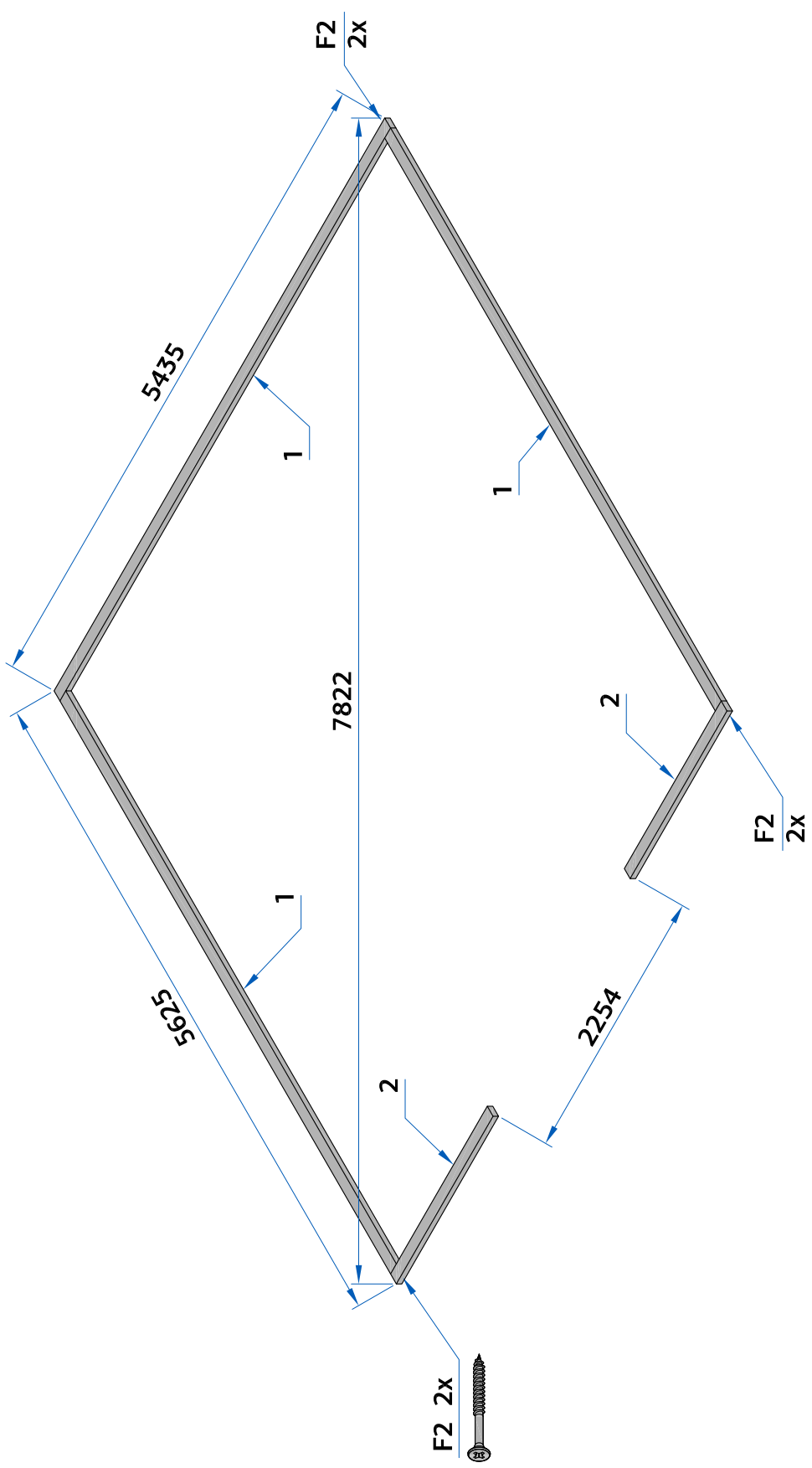



3

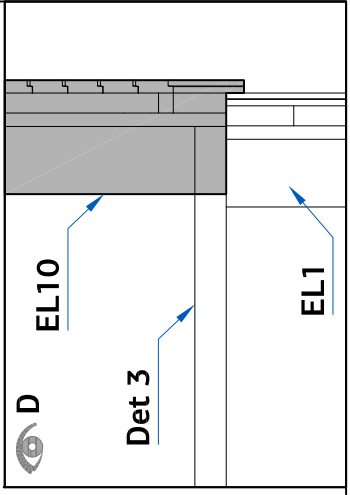
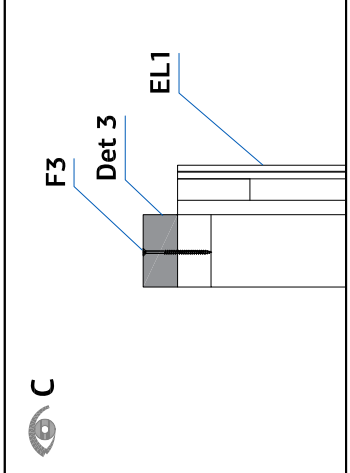
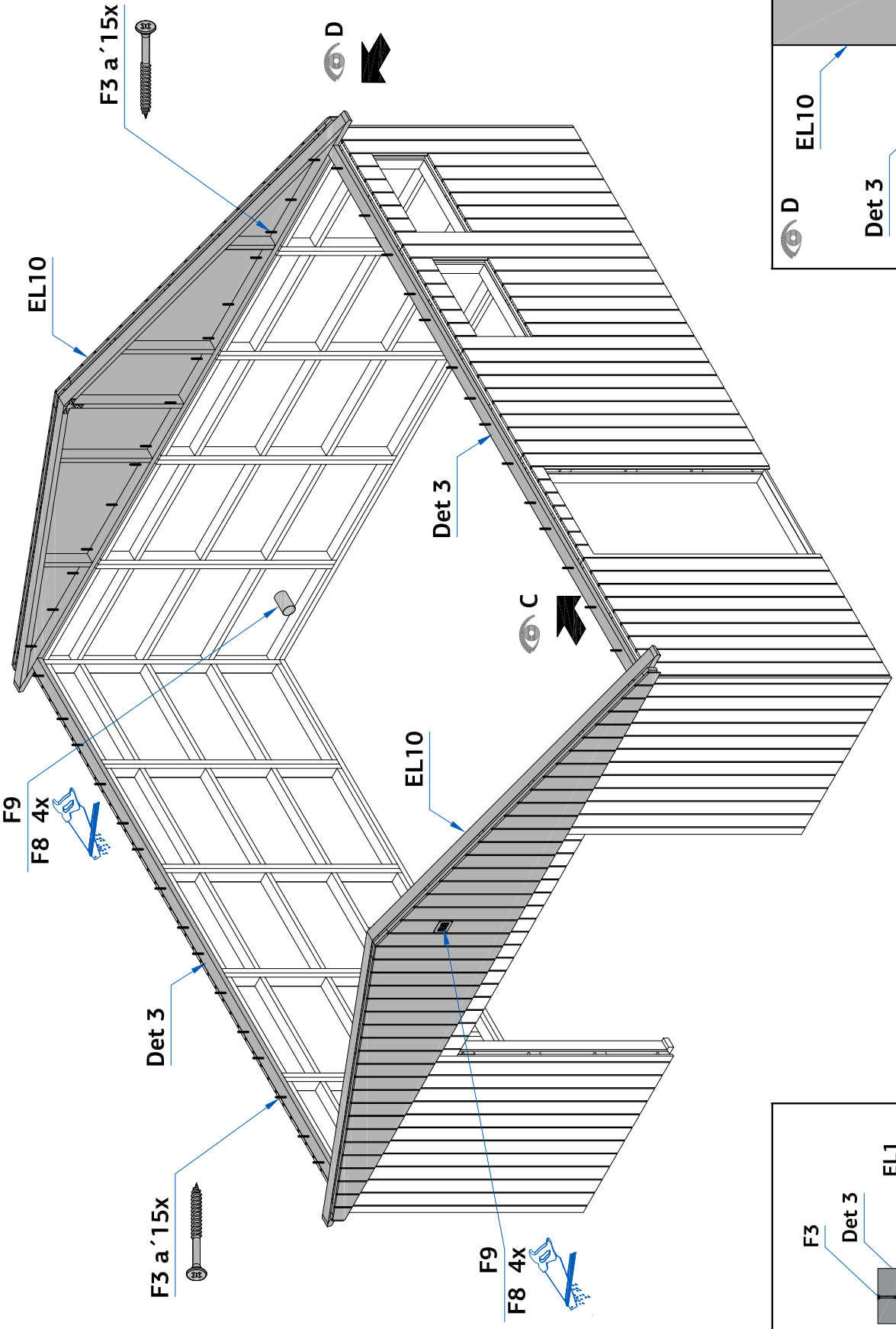

4

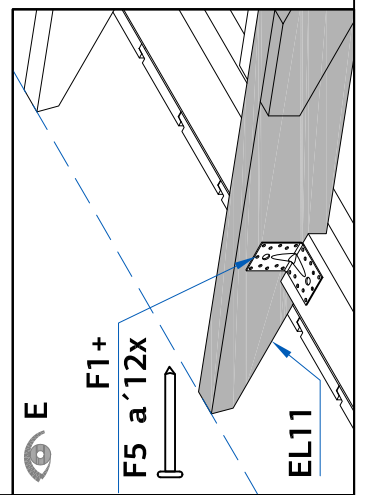
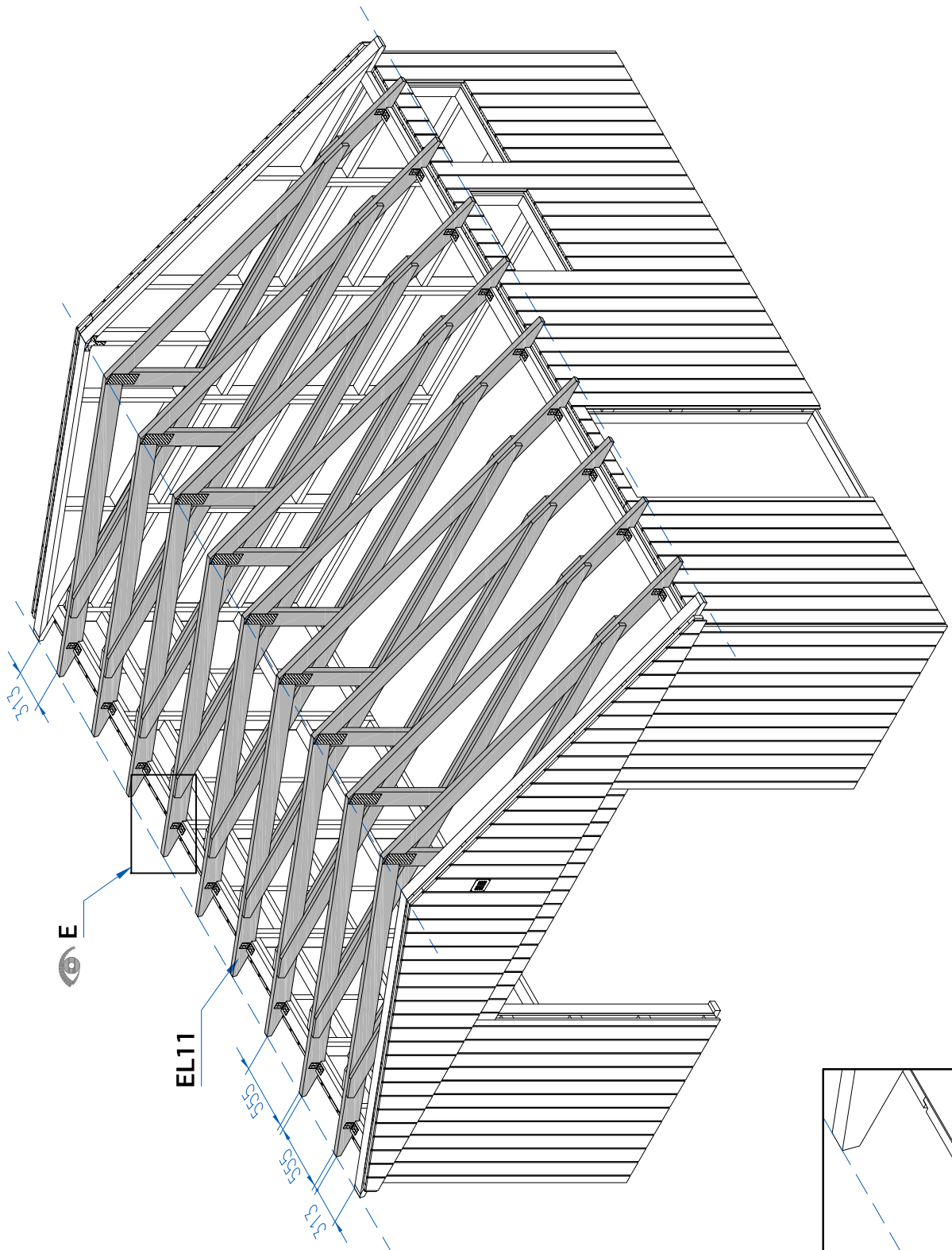



5

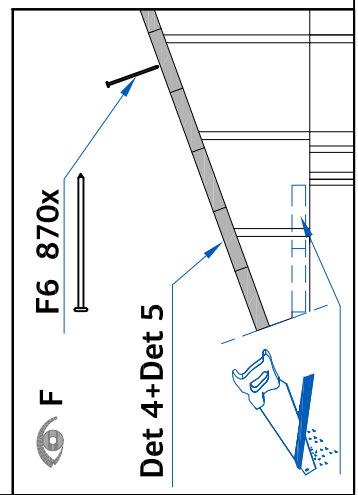
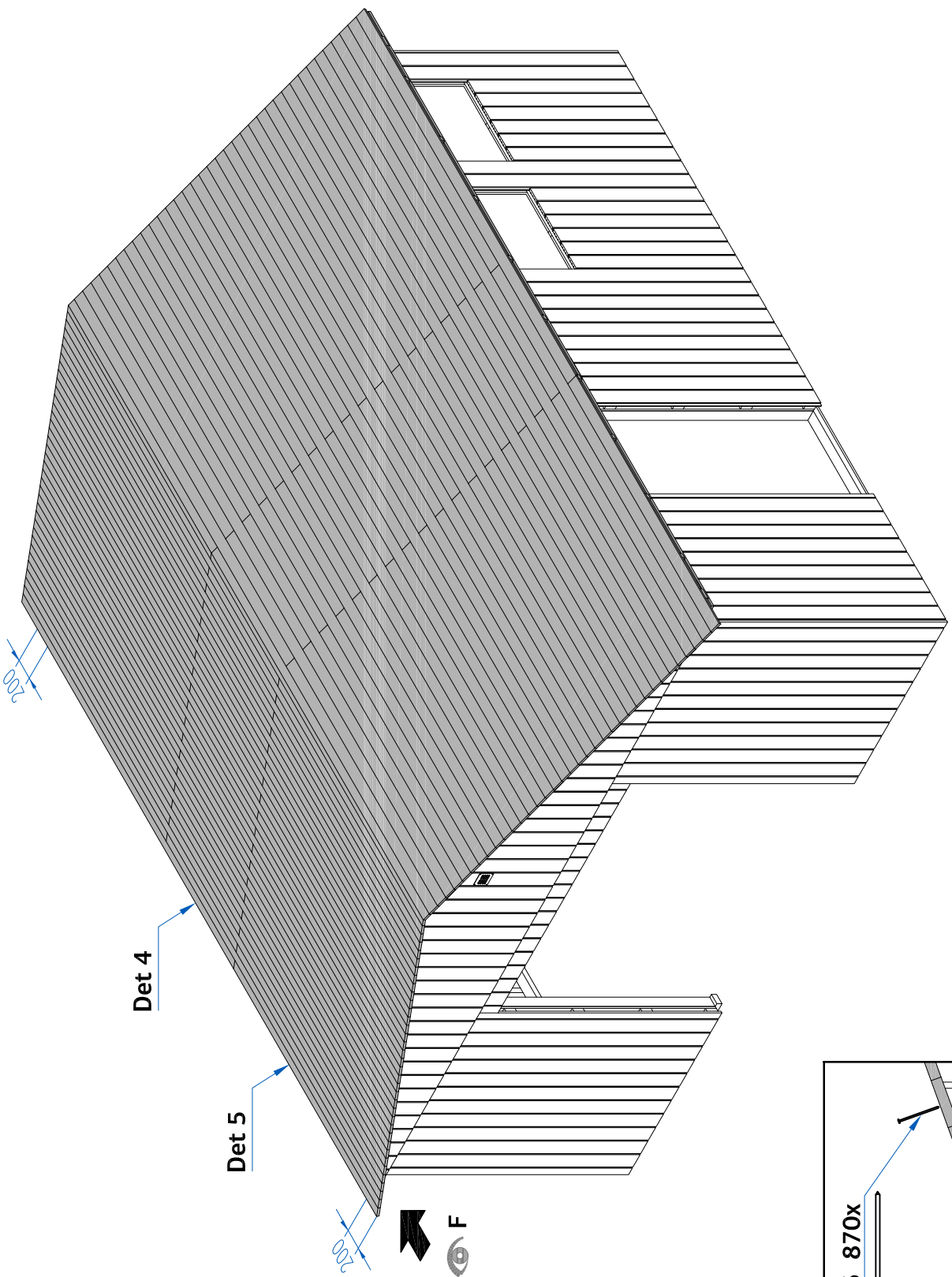

6

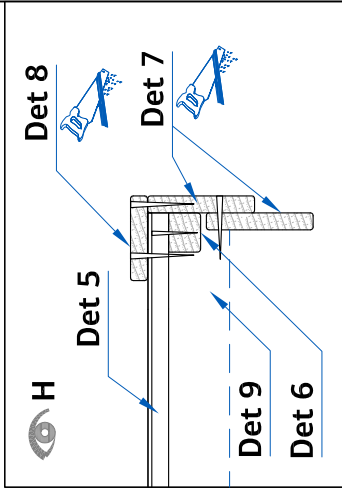
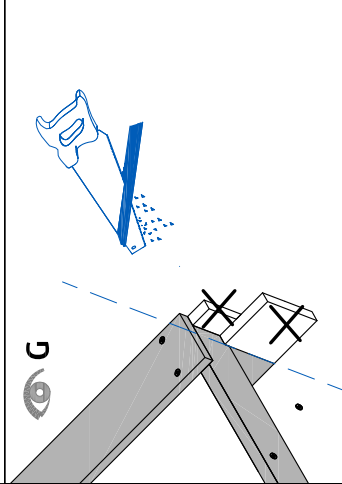
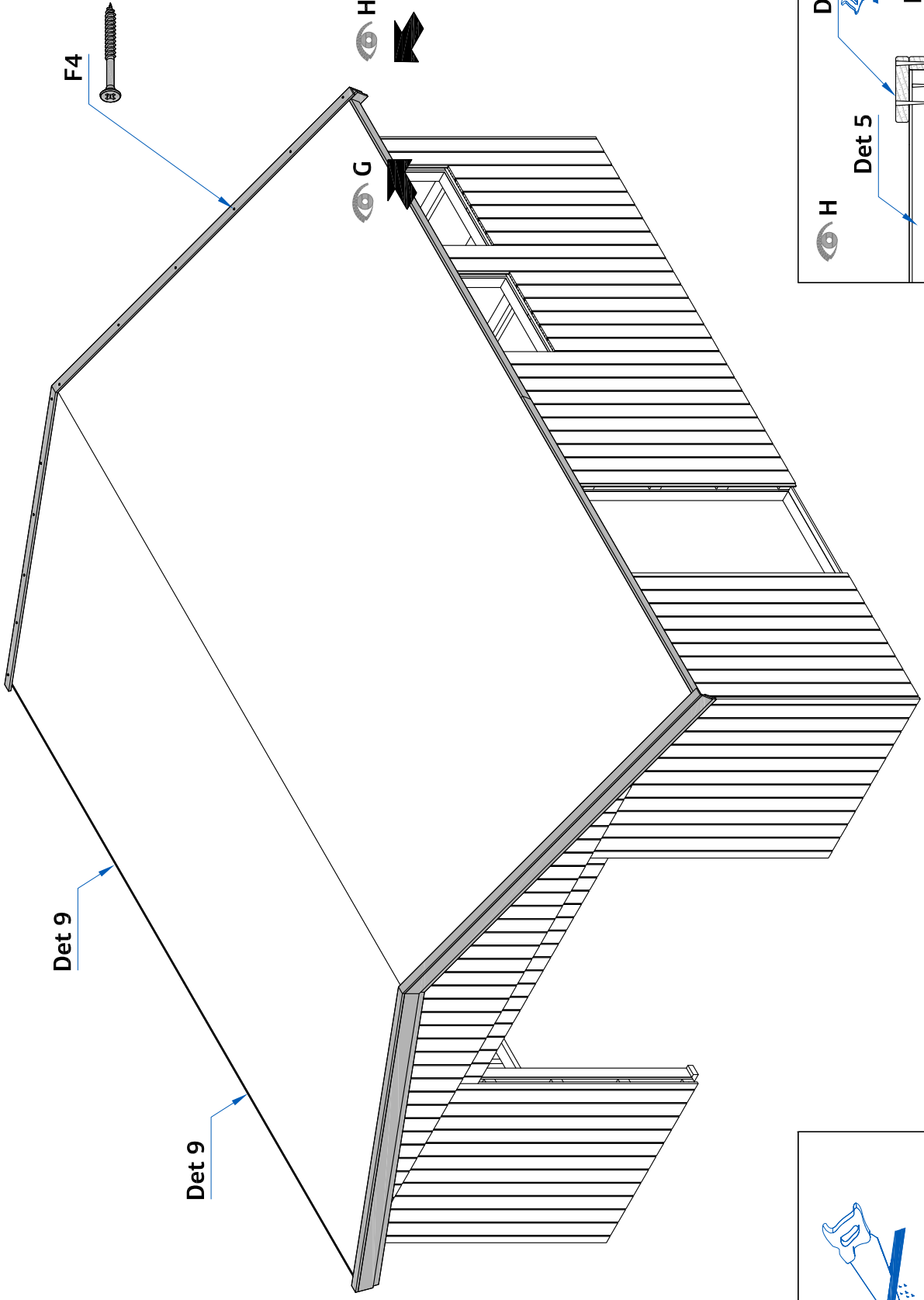

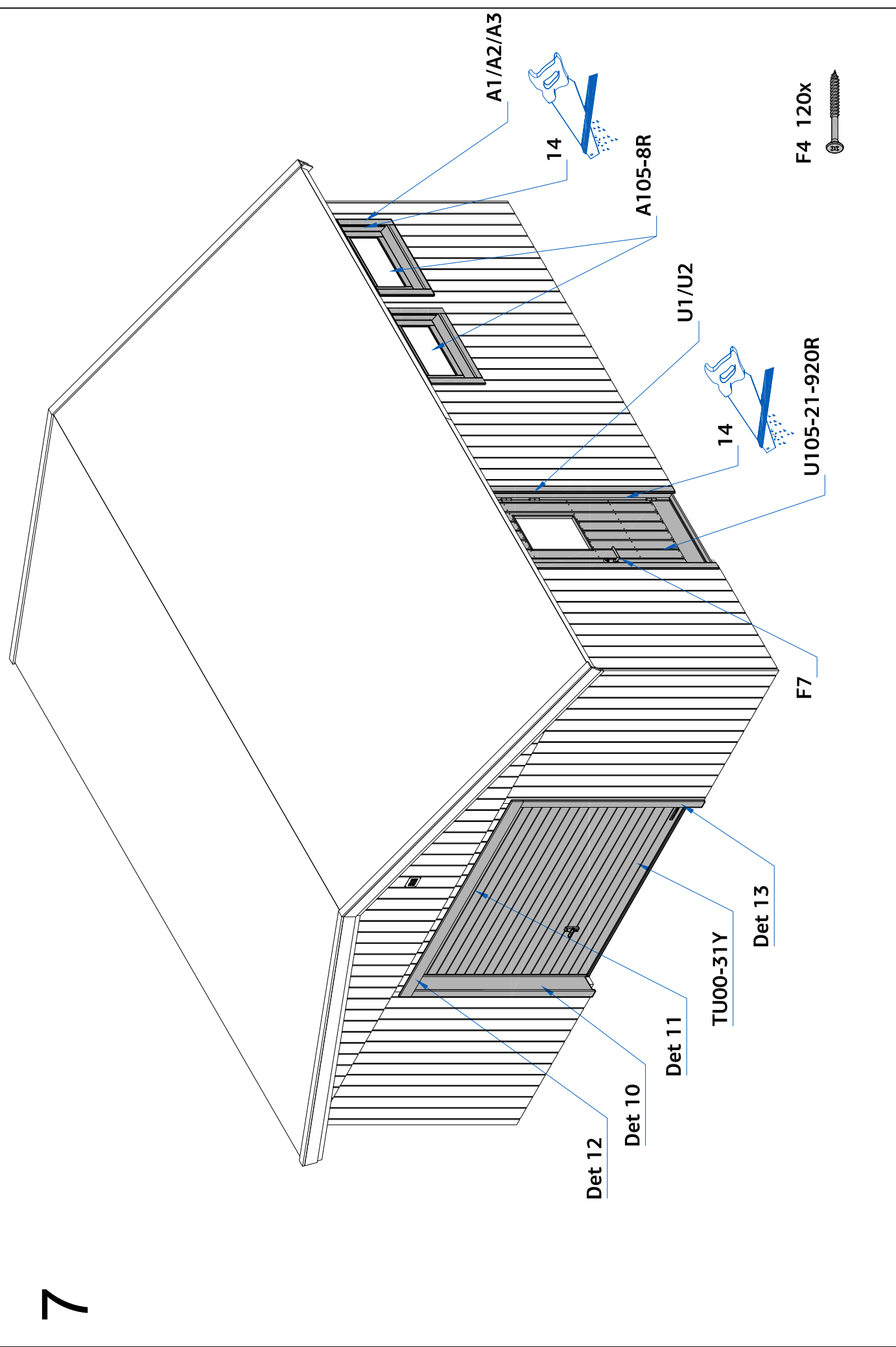

## 1 General information



**Dear client,**

We are glad that you have decided in favour of our garden house!

**Please read the assembly manual carefully before proceeding with the house installation!** You will thus avoid problems and will not waste time.

### **Recommendations:**

- Keep the house package until its complete assembly in a dry place, but not in direct contact with the ground, protected from weather conditions (moisture, the sun, etc.). Do not keep the house package in a heated room!
- When selecting the garden house location, make sure that the house will not be subjected to extreme weather conditions (areas of strong snowfall or winds); otherwise you should attach the house (for instance, with anchors) to the subsoil.



### **Warranty**

Your house is made from high quality fir and delivered in the natural (unprocessed) form. If, despite our thorough inspection, you should have complaints, please submit the filled out control sheet and purchase invoice to the product seller.

**ATTENTION: Please be sure to keep the documentation accompanying the house package! The control sheet includes the control number of the house. We can only review complaints if you submit the control number of the house to the seller!**

The warranty does not cover:

- Peculiarities of wood as a natural material
- Wooden details already painted (processed with a wood preservative)
- Wooden details containing whole branches that do not endanger the stability of the house
- Colour tone variations caused by wood structure differences that do not influence wood lifetime
- Wooden details containing (caused by drying) small cracks/gaps that do not pass through and do not influence the structure of the house
- Twisted wooden details if they can nevertheless be installed
- Roof and floor boards that may have on their concealed surfaces some non-planed areas, colour differences and waning
- Complaints resulting from an incompetent manner of the installation of the house or the house subsiding due to an incompetently made foundation
- Complaints caused by introducing self-initiative changes to the house, such as the deformation of wooden details and doors/windows due to an incompetent manner of wood processing; the attachment of storm braces too rigidly, doorframes being screwed onto wall logs, etc.

**The complaints covered by the warranty are satisfied to the extent of replacing the deficient/faulty material. All other demands will be excluded!**



## Garden house painting and maintenance

Wood is a natural material, growing and adapting depending on weather conditions. Large and small cracks, colour tone differences and changes, as well as a changing structure of wood are not errors, but a result of wood growing and a peculiarity of wood as a natural material.

Unprocessed wood (except for foundation joists) becomes greyish after having been left untouched for a while, and can be turn blue and become mouldy. To protect the wooden details of your garden house, you must immediately process them with a wood preservative.

We recommend that you cover the floor boards in advance with a colourless wood impregnation agent, especially the bottom sides of the boards, to which you will no longer have access when the house is assembled. Only this will prevent moisture penetration.

We definitely recommend that you also process the doors and windows with a wood impregnation agent, and do that namely both inside and outside! Otherwise the doors and windows can become twisted.

After the house assembly is completed, we recommend for the conclusive finishing a weather protection paint that will protect wood from moisture and UV radiation.

When painting, use high quality tools and paints, follow the paint application manual and manufacturer's safety and usage instructions. Never paint a surface in strong sunlight or rainy weather. Consult a specialist regarding paints suitable for unprocessed softwood and follow the paint manufacturer's instructions.

Having been properly painted, your garden house's lifetime will increase substantially. We recommend that you inspect the house thoroughly once every six months.

## 2 Preparation for assembly

### Tools and preparation of components

To assemble the garden house, you will need the following tools:



assembly aid



ladder



hammer



water-level



screwdriver



saw



knife



measuring tape



pliers



drill

**ADVICE:** To avoid splinters, we recommend that you wear the corresponding protective gloves during the assembly process.



**We wish you total success with the garden house installation and much joy with this house for many years to come!**